

OPTOTRONIC® LED Power Supply OT100W/UNV/1250C/2DIMLT2/P6 - Technical Specifications



ELECTRICAL SPECIFICATIONS

Input

Input Voltage (VAC)	120V-277V (+/- 10%)	
Frequency Range (Hz)	50 – 60 Hz (+/- 10%)	
	120V	277V
Input Current (A)	0.95	0.40
THD @ Full load	<10%	<10%
Power Factor @ Full load	>0.95	>0.95
Efficiency @ Full load	≥86%	≥90%
Inrush Current (A _{pk})	15A,50µs	32A,50µs

Output

Output Current (mA)	600-1250mA 1mA resolution (programmable)
Output Voltage (VDC)	30-100VDC
Output Ripple Current	<25% @ 1250mA
Max. Output power (W)	100W (model dependent)
LED Power-up time	< 0.5sec
Load Regulation	<5%
Line Regulation	<5%
Over voltage protection	Yes, non- latching
Over load protection	Power fold back @105W
Output short-circuit protection	Yes, non- latching

Dimming

Dimming Control	0 – 10V (Isolated)* AstroDIM
Dimming Range	10-100% (50mA min)
Dimming Type	Analog
Source/Sink Current	1mA

* Class 2 or non-Class 2 wiring allowed

GENERAL INFORMATION

Item Number	79369
Type	Constant Current
Output Power	100W (Max.)
Programming tool	51645; Software
Programmable features	Output current
	Dimming level
	LED thermal protection
	AstroDIM
	LEDSet Gen2
	Constant Lumen output
	End of life indicator

ELECTRICAL SPECIFICATIONS

LED thermal protection (NTC)

NTC value active range	≤ 25kΩ
Output level minimum	User defined

Ambient Operating Temperature	-40 °C to 55 °C
Case Temperature (T _c)	85°C** 90°C (max)
Max. Storage Temp.	70°C
Max. Relative Humidity (%)	95% non condensing
Transient Protection	ANSI C62.41 Cat.B 6.0kV
IP Rating	IP66
UL Environmental Rating	Damp & Wet
UL File number	E320395
EMI Compliance	FCC Part 15 Class A
Sound Rating	Class A

**- Warranty applicable only at 85°C



WIRING DIAGRAM

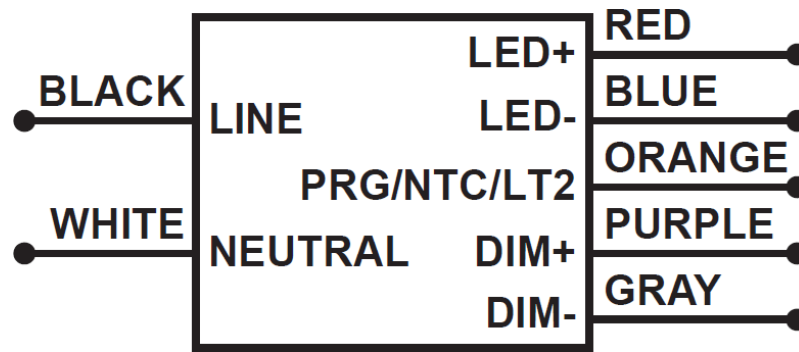

Note 1: Maximum suggested remote mounting distance is 16 feet. For additional information on further distances and EMI compliance reference application note LED126.

Note 2: The Dimming input is isolated and will allow Class 2 or non-Class 2 wiring across Purple and Gray wires

MECHANICAL DIAGRAM

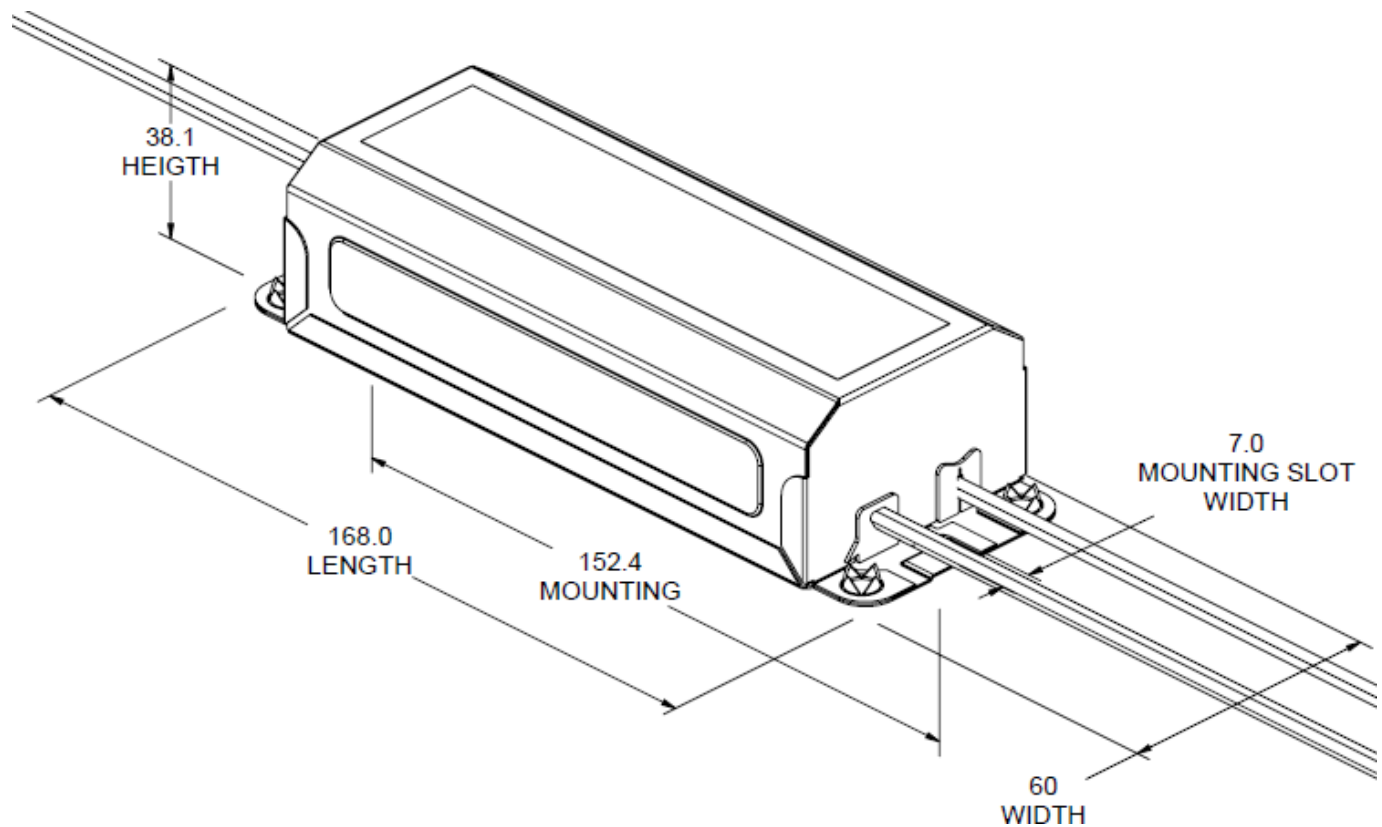

MECHANICAL DIAGRAM

Length	6.61" (168mm)
Width	2.36" (60mm)
Height	1.5" (38.1mm)
Mounting length	6.0" (152.4mm)
Mounting slot width	0.28" (7mm)

OPERATING RANGE

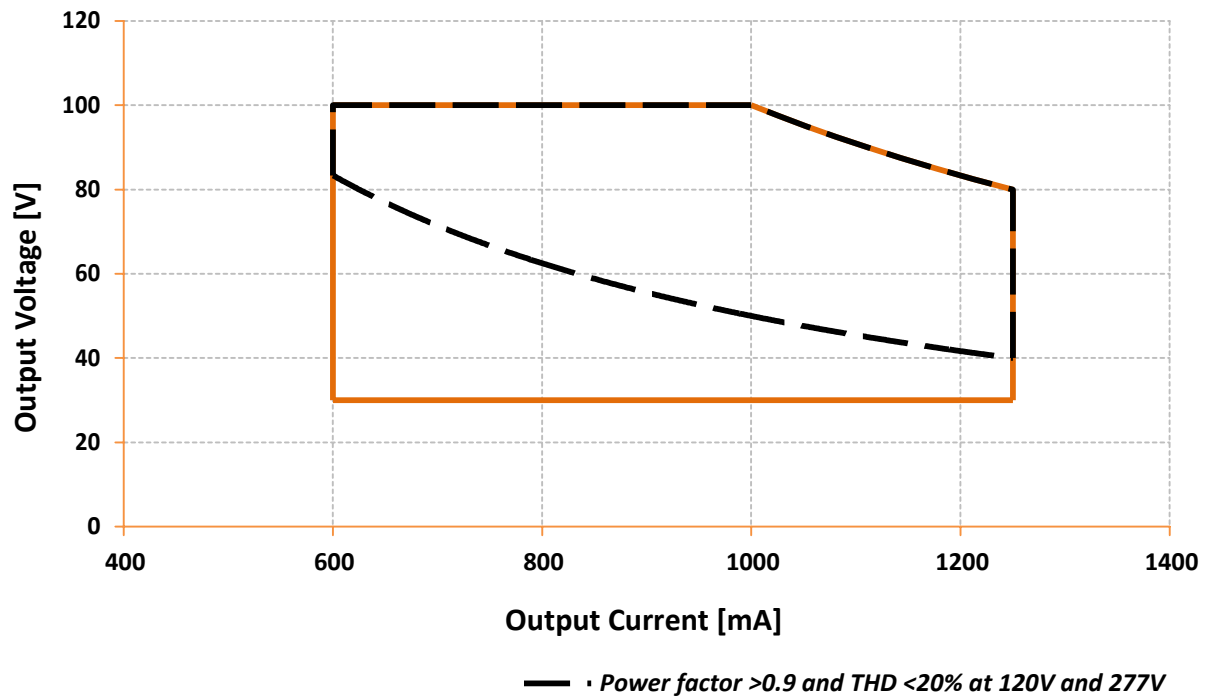

DIMMING CURVE

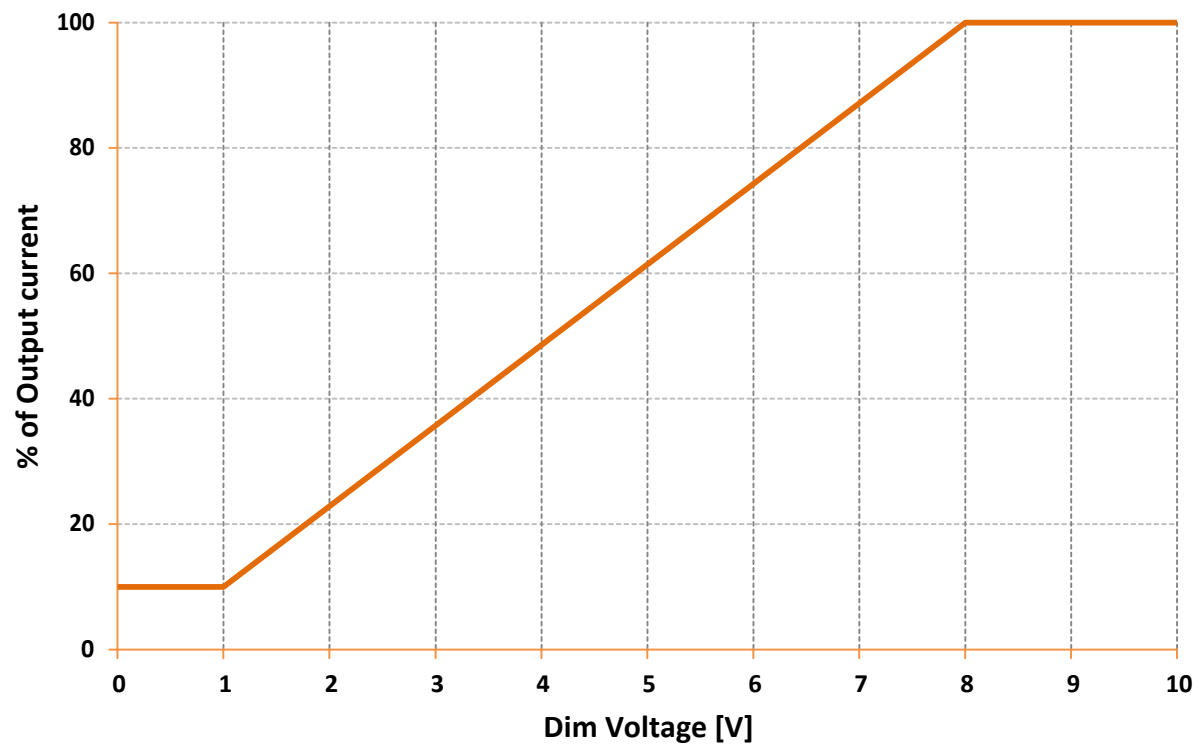

**The absolute minimum current the driver can deliver is 50mA*

EFFICIENCY VS OUTPUT VOLTAGE

Efficiency @ 277V

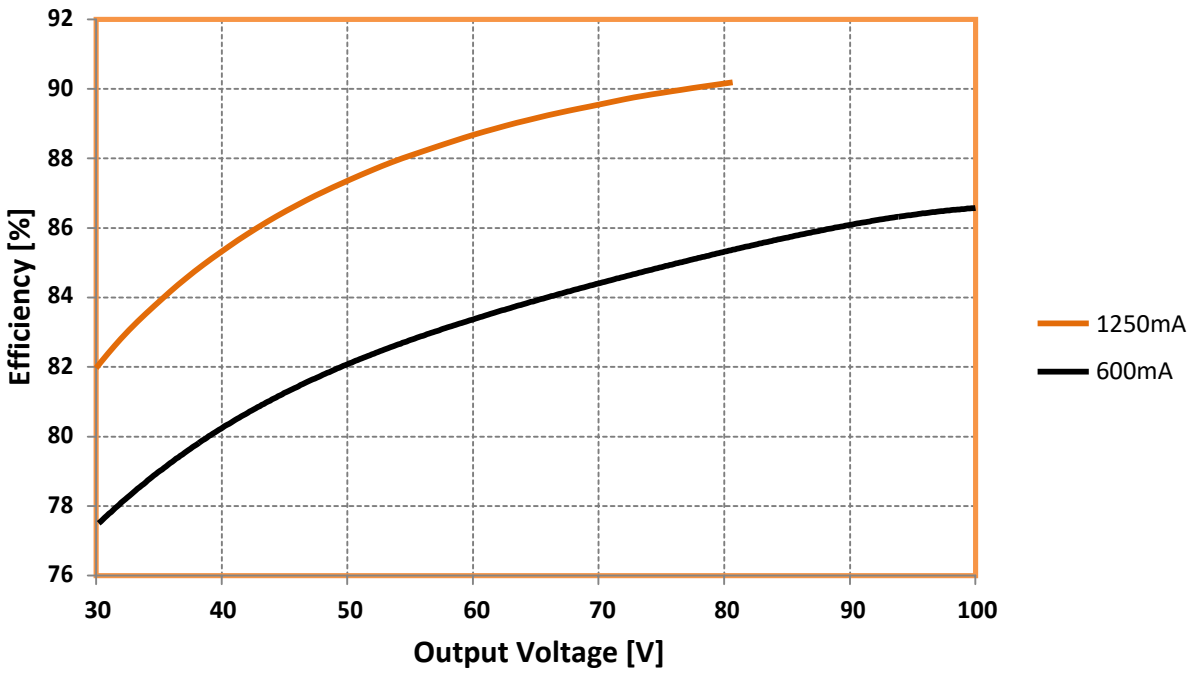

Efficiency @ 120V

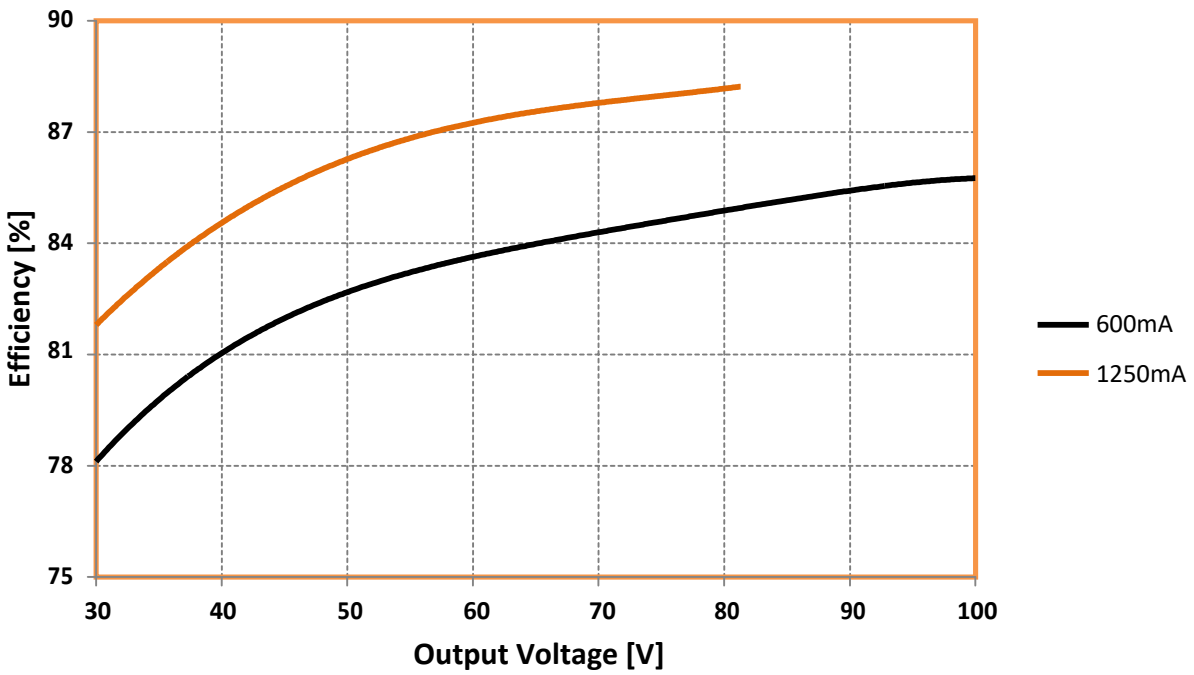

POWER FACTOR PERFORMANCE

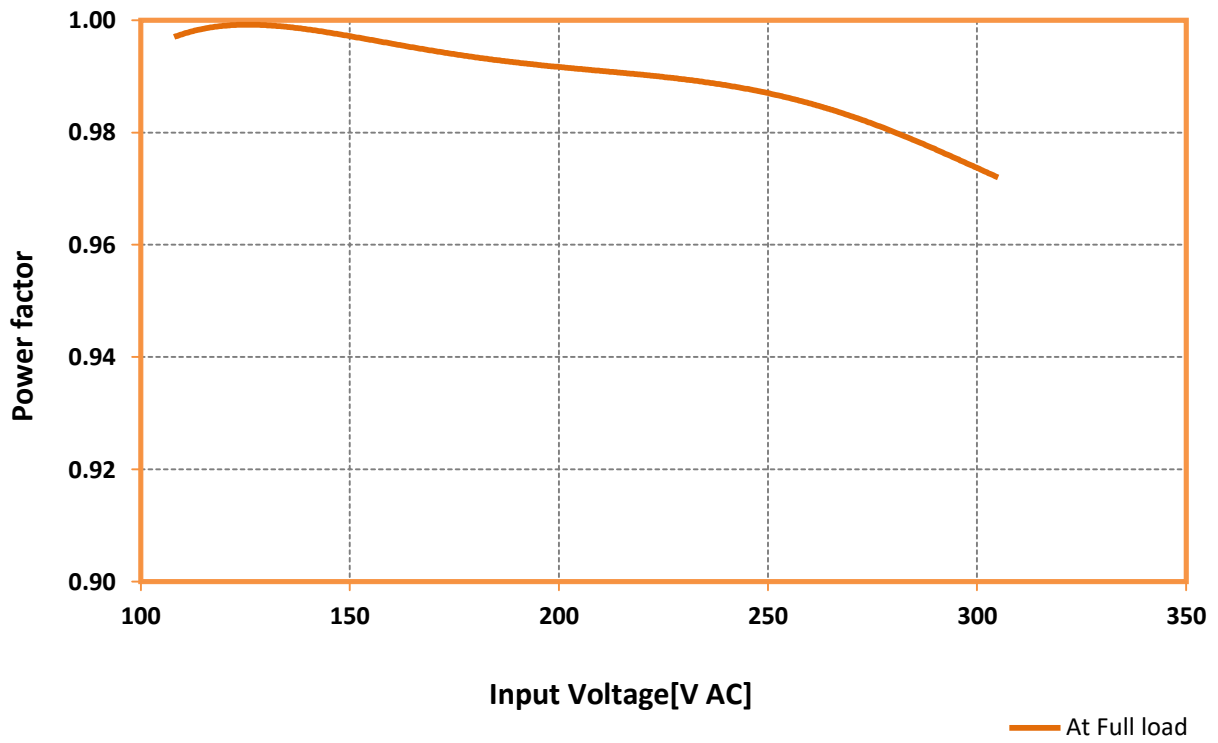
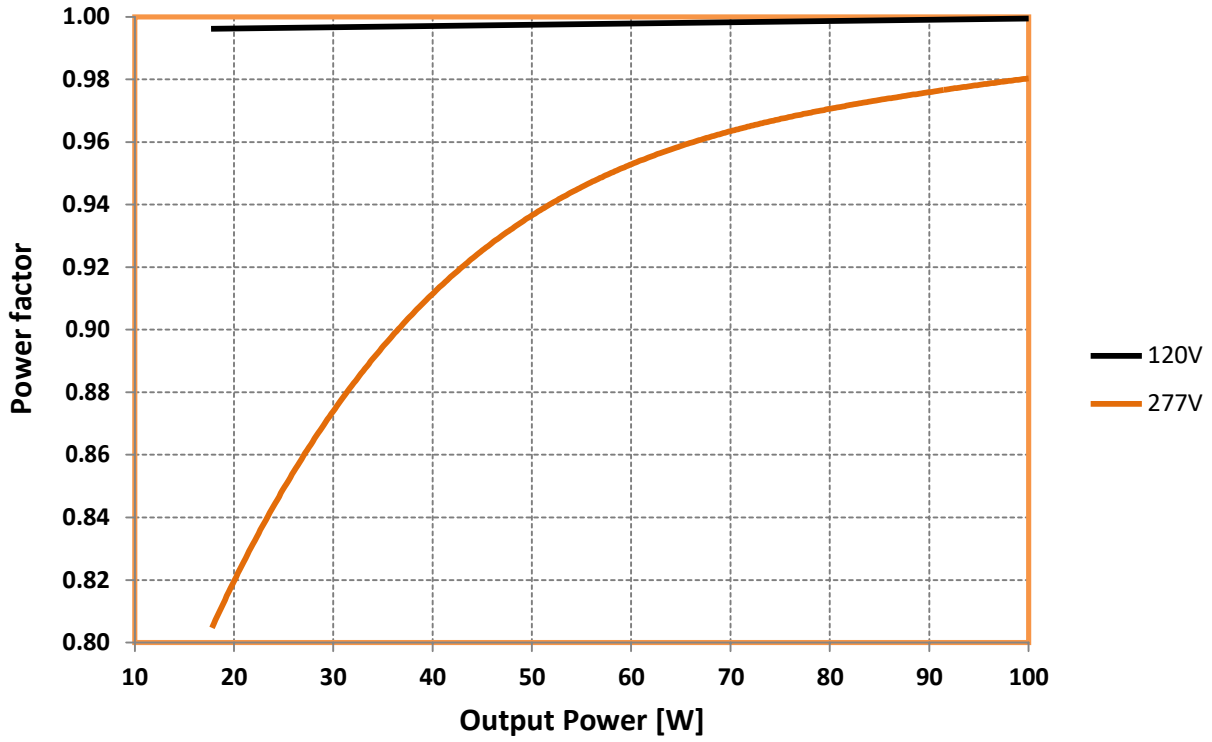

THD PERFORMANCE

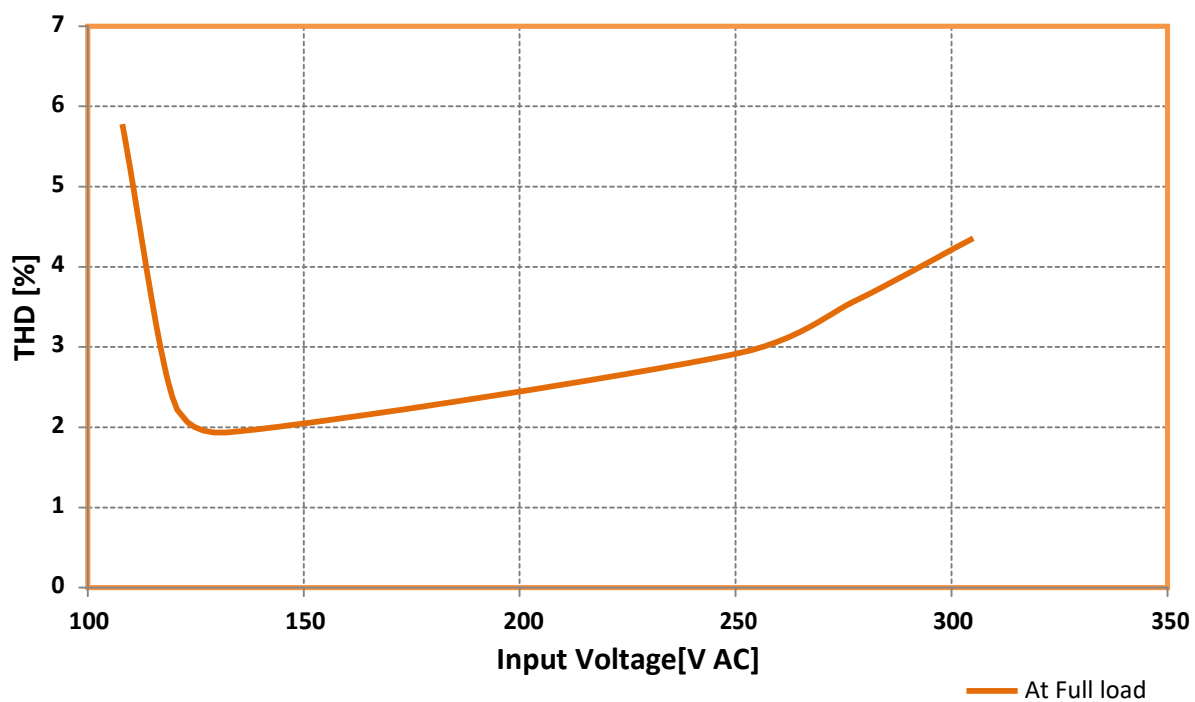
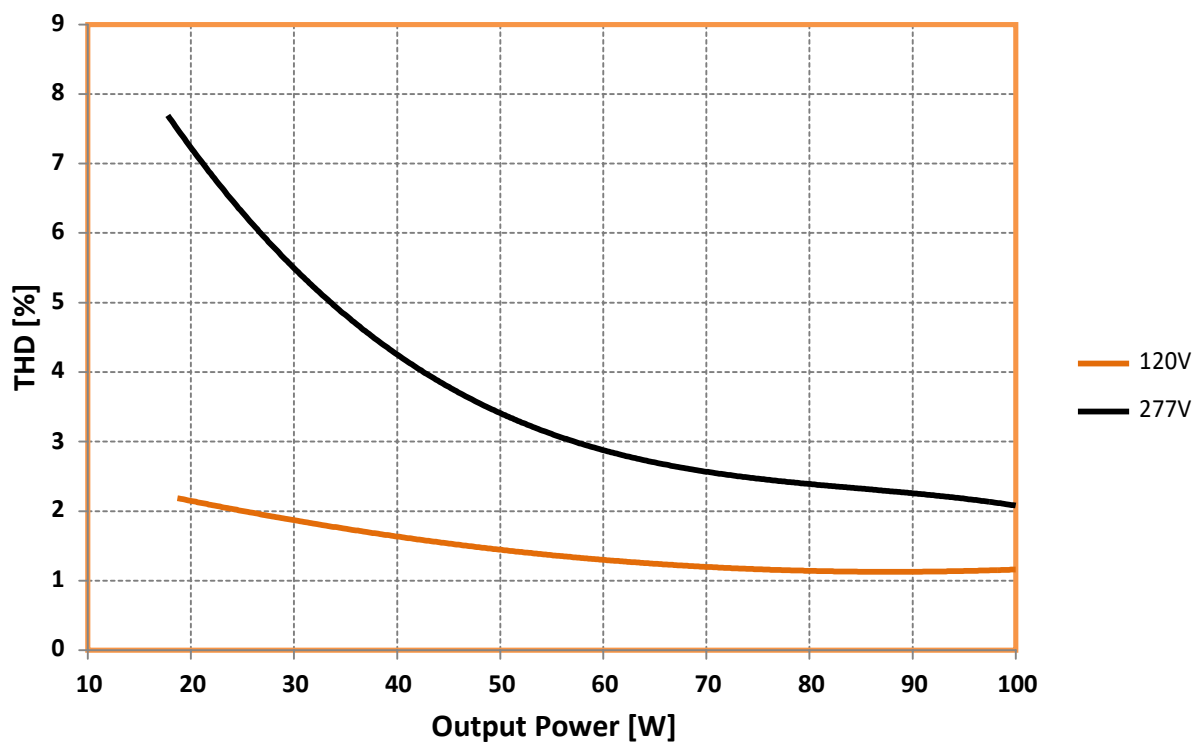

LED THERMAL PROTECTION (NTC) CHARACTERISTIC

The LED thermal protection feature of the OT100W helps reduce the temperature of the LED module by reducing the output current in case of abnormal temperature conditions. To use this feature a third party NTC thermistor should be connected to the LED power supply as shown in the wiring diagram below.

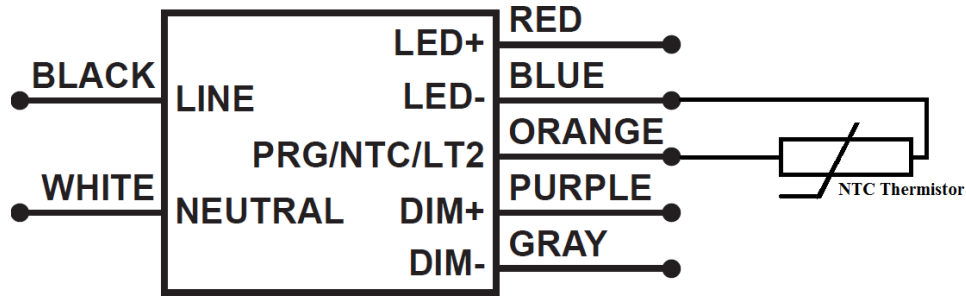

In the end application, care must be taken to place the NTC thermistor close to the hottest spot on the LED module. If LED thermal protection is not required the NTC port on the LED power supply connector can be left open.

Vishay, EPCOS, Murata, Panasonic are some of the manufacturers of NTC thermistor. EPCOS part number for reference only **B57164K153J (15kΩ @ 25°C)**. Murata part number for reference only - **NCP03XH223J05RL (22kΩ @ 25°C)**

Note 2: Graphs for reference. The de-rating limits can be programmed using the OT Programmer

Derating start = 6.3kΩ; Derating end = 4.3kΩ; Min output level = 10%

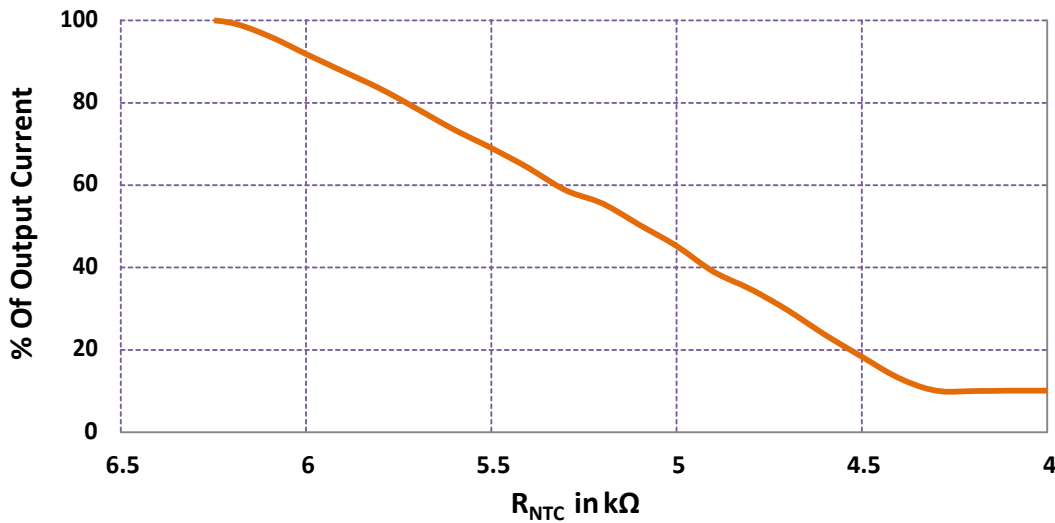

AstroDIM

AstroDIM is an autonomous five level (1 Power ON & 4 Dimming levels) dimming protocol. It provides multi-stage night-time power reduction based on an internal timer; there is no need for an external control infrastructure. The ECG is automatically aligned to the on and off times for the street lighting and provide a defined output for the particular period of time. Compared with conventional systems there are significant cost savings. AstroDIM is designed for dimming without any external control wiring. Therefore, AstroDIM helps to save energy, extend the life of the driver and the LED module and reduce light pollution, even if only a power line is available. In AstroDIM operation, the driver executes a preset dimming profile, which can be reconfigured via the OT Programming Tool. The autonomous dimming is regulated by an integrated timer (no real-time clock), which adjusts the dimming profile according to the previous night (operation from switch-on to switch-off).

For detailed information on AstroDIM please refer to *Technical Application guide 2DIM feature* (LED 408)

LEDset 2

LEDset (Gen2) is an analog interface, allowing basic communication between a LED control gear and one or more LED modules. It allows setting the output current of the LED driver by providing a highly accurate voltage reference

(Vset) to the driver. The interface supports the following functions:

- Output current setting of the constant current LED control gear to single LED modules as well as to series/parallel connected LED modules
- Best matching of LED control gear and modules working point
- Self-configuration according to system structure, automatic tracking of technology development
- Easy mode of operation
- Additional monitoring & protection features (e.g. thermal protection of the LED modules)

Therefore, the typical applications of this interface are single or multiple LED module parallel connections, offering an increasing choice of modular capabilities and low cost thermal protections circuits.

For detailed information on LEDset interface please refer to *Technical Application guide LEDset interface* (LED 409)

Note 3: When the LEDset feature is enabled, the LED Thermal protection (NTC) feature is disabled.

CONSTANT LUMEN MAINTENANCE

The Constant Lumen Maintenance feature of the OT100W helps to maintain the required lumen output of the fixture at a constant level throughout its lifetime. In general LED's lumen output will depreciate over time and in order to maintain sufficient light level towards the end of lifetime, the LED's are driven at high current initially and will result in more energy consumption. The constant lumen maintenance will give the flexibility to drive the LEDs at optimal driving current throughout its lifetime. This helps in energy savings, constant light output and enhanced reliability of the system.

Note 4: A detailed step-by-step instructions are outlined in the '[OT Programmer User Manual V2.1](#)'

END OF LIFE INDICATOR

The End-of-Life indicator feature helps the end user to receive a signal from the fixture indicating that it has reached its programmed life-time. After the LED driver reaches the programmed life-time, whenever it is turned ON, it stays at 'Dim' level (10%) for 10 minutes and reaches its appropriate level.

LIFETIME VS CASE TEMPERATURE

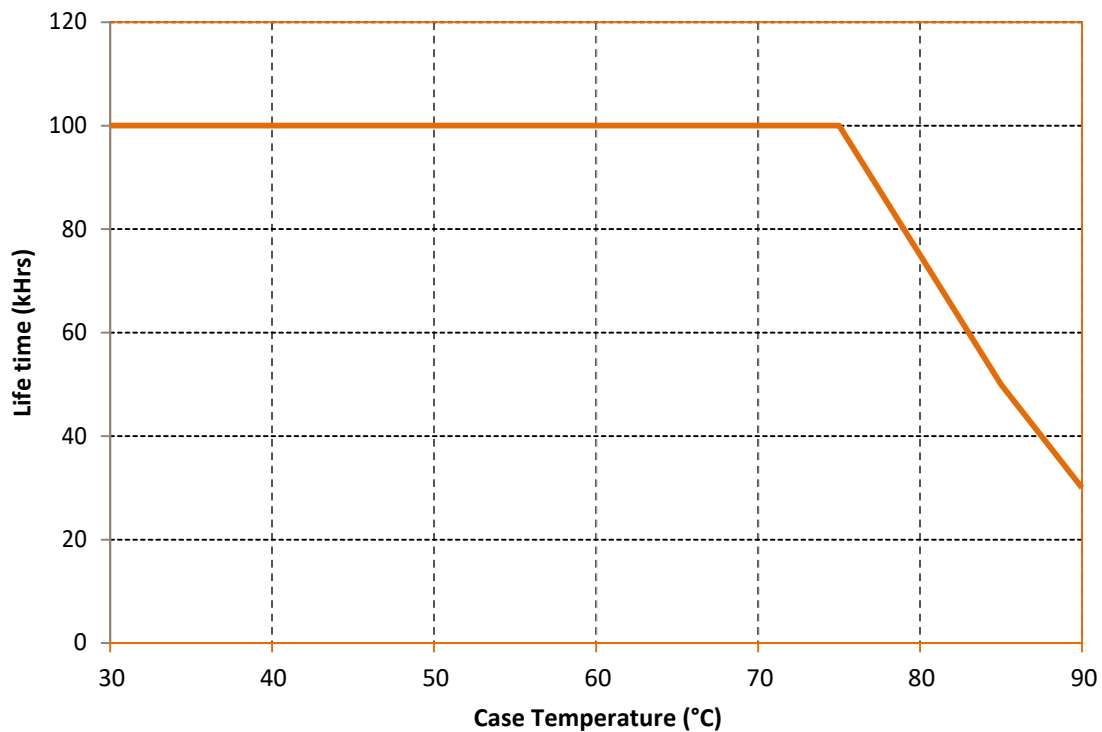

INRUSH CHARACTERISTICS

Vin (V)	Ipeak (A)	T (@ 50% of Ipeak)
120	15	50 μ s
277	32	50 μ s

Manufacturer	Part no
Encelium EMS	EN-LCM-1R10V-GB2-BK EN-LCM-1R10V-GB2-BK/DR EN-ALC-1R10V-GB2-BK EN-ALC-1R10V-GB2-BK-DR
SYLVANIA	ELMC-SL3W-TVWBX/UNV
Leviton	IP710-DLX
Lutron	DVTV-XX
Wattstopper	ADF-120277
Synergy lighting Controls	ISD BC

Note 5: The absence of a dimmer from this chart does not necessarily imply incompatibility. Please reference the dimmer manufacturer's instructions for installation.

UL CONDITIONS OF ACCEPTABILITY (E320395)

Conditions of Acceptability – When installed in the end-product, consideration shall be given to the following:

- The LED driver was evaluated using an electronic LED load resulting in an output rated current and rated power.
- The unit employs a Class B insulation system on the isolation transformer (L300). Model OT100/UNV/800C/2DIMLT2/P6 the transformer was 104.6 °C, and the TC point on the case was 89.9°C at an ambient normalized to 60°C. The Highest temperature recorded on Model OT100/UNV/1250C/2DIMLT2/P6 transformer was 104.5°C the TC point on the case was 89.9°C at an ambient normalized to 55°C. The need to repeat the temperature test shall be determined in end-use product. During the normal temperature test of the end product, the temperature at any point on the case is to be monitored and shall not exceed 90°C. When provided the tc in a circle can be a considered a reference hot spot on the case
- The unit was tested on a 20 A branch circuit. If used on a branch circuit greater than this, additional testing may be necessary.
- The PWB spacings for use in a wet locations have been evaluated to UL8750 spacing requirements. The Unit is completely potted spacing requirements comply with Table 7.4 in UL8750, Parts Potted or subsequently coated.
- These drivers are suitable for dry, damp or wet locations.

WARRANTY

OPTOTRONIC® products are covered by our LED Module, OPTOTRONIC Power Supply or Control Warranty. For additional details, refer to the latest version of the warranty (LED089) available at www.osram-america.com/optotronic